

# The Truth About the Fidelity of High-Bandwidth Voltage Probes

Application Note 1404

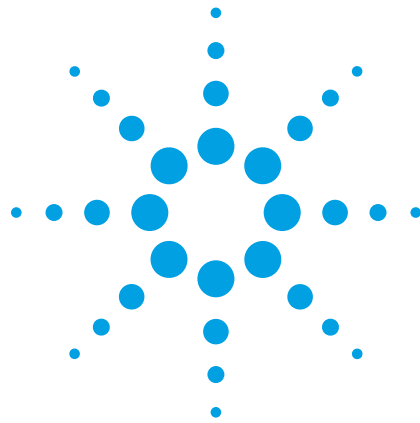

## Who Should Read This Application Note?

This application note is intended for users of high-bandwidth voltage probes. It presents an analysis of high-bandwidth voltage probes that is detailed enough to accurately describe their behavior, yet is simple enough to maintain a clear understanding of what is going on and why. The analysis reveals a fundamental tradeoff between fidelity and ease of use that exists with all high-bandwidth probes. A new topology that alleviates this fundamental tradeoff will be presented, along with measurements that compare the new topology to older ones.

### Table of Contents

<b>Who Should Read This Application Note?</b> .....	<b>1</b>
<b>Electrical Model</b> .....	<b>2</b>
<b>Probe Characteristics</b> .....	<b>6</b>
<b>Measurement Setup</b> .....	<b>8</b>
<b>Practical Considerations</b> .....	<b>9</b>
<b>Undamped vs. Damped Connection Accessories</b> .....	<b>10</b>
<b>Comparison of Best Connection Accessories</b> .....	<b>15</b>
<b>Summary</b> .....	<b>19</b>
<b>Support, Services, and Assistance</b> ..	<b>20</b>



# Electrical Model

Figure 1 shows a picture of a probe and oscilloscope measuring the voltage between a point on the leg of a surface-mounted device and a ground plane. First of all, the exact location of the probe input needs to be clearly defined. When accessories such as pins or short wires are used to connect a probe to a circuit, the exact location of the probe input can become ambiguous. Is it on the probe side or the circuit side of a short wire? What is being measured is the voltage between two points on a circuit, hence the input of the measuring device is, by definition, at the points where the probe connects to the circuit. Said differently, connection accessories become part of the probe. Figure 1 refers to the voltage at the probe input as “ $V_{IN}$ ”.

A simplified electrical model of the probe and scope appears at the bottom of figure 1. The parasitics of the connection to the circuit can be modeled either as coupled transmission lines or as discrete, lumped inductors and capacitors. Figure 1 shows a lumped model of the connection that incorporates series coupled inductors,  $L_S$  and  $L_G$ , and shunt capacitors,  $C_C$ . A compensated R-C voltage divider inside the probe isolates the relatively high capacitance of the buffer amplifier from the probe input and also attenuates the input signal. Without the attenuator, the input capacitance of the probe would be  $C_C + C_{AMP}$ ; but with a 5:1 attenuator, for example, the input capacitance is  $C_C + C_{AMP}/5$ .

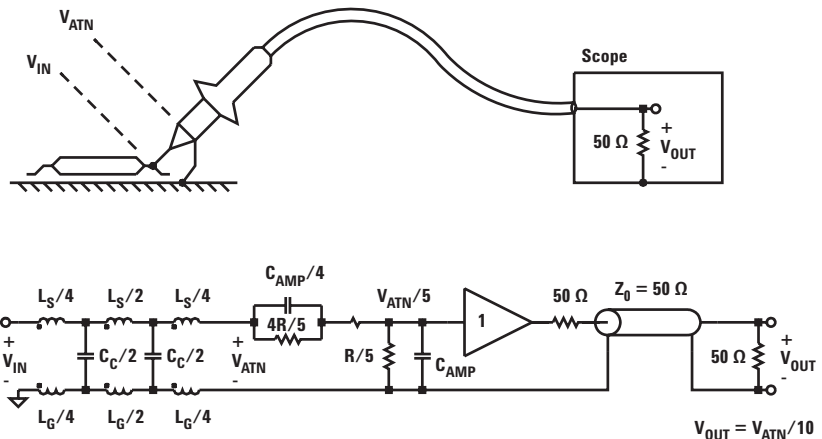

Figure 1. Physical sketch and electrical model of a typical active voltage probe

After the compensated voltage divider the first part of the probe is a buffer amplifier that can drive the terminated transmission line to the scope. In this simple schematic, the voltage at the probe output, which is also the scope input, exactly replicates the voltage at the attenuator input,  $V_{ATN}/5$ . The only discrepancy between the waveform at the scope input,  $V_{OUT}$ , and the waveform being measured,  $V_{IN}$ , is the 10:1 scale factor and the response from  $V_{IN}$  to  $V_{ATN}$ .

The schematic in figure 1 can be separated into two very distinct parts. The first part models the physical connection between the points being measured and the attenuator input. The second part models everything after the attenuator input. The second part is constant and, assuming the probe was designed well, has a reasonably flat response throughout the specified

bandwidth of the probe. The first part, however, is not constant and depends on the geometry of the physical connection.

Obviously, more circuitry exists inside a probe than this simple schematic shows. A more complete schematic of a high-bandwidth probe would also include tweaks to the compensated attenuator, the active devices in the amplifier, offset and power supply circuits, and a network that compensates for the loss of the cable to the scope. None of these components are included in this model because, if they were designed well, they do not dominate the response of a high-bandwidth probe. What does dominate the response of high-bandwidth probes is the first part of the model, which is determined by the geometry of the physical connection.

## Electrical Model (continued)

Figure 2 focuses on the connection between the points being measured and the probe attenuator. The impedance looking into the attenuator is  $R_{DC}$  in parallel with  $C_{AMP}/5$ , which is labeled  $C_{ATN}$ .

In order to accurately model arbitrary input connections, the impedance seen looking back into the outer conductor of the coaxial cable needs to be included in the model. This impedance can be thought of as a transmission line formed between the outer conductor of the coaxial cable and earth ground. It's really an antenna, but it can be accurately modeled as simply  $R_{EXT}$  in parallel with  $L_{EXT}$ . Based on time-domain reflectometry (TDR) measurements, typical values are around 250-ohms and 2- $\mu$ H.

With the inclusion of  $R_{EXT}$  and  $L_{EXT}$ , the behavior of poorly grounded probes can be better understood. The worst case is a probe with no ground connection at all, which removes  $L_G$  from the schematic. As many designers know from experience, an ungrounded probe still produces somewhat reasonable waveforms. Looking at the model with  $L_G$  removed, if  $R_{EXT}$  was not included, then the voltage across the probe attenuator would be nearly zero at higher frequencies and nearly zero at higher frequencies, which isn't true. It is current through  $R_{EXT}$  that charges the capacitance at the attenuator input at high frequencies and produces a somewhat reasonable response when using a probe

with no ground connection. There are many caveats, however. The probe does not reject any difference between system ground and probe ground.  $R_{EXT}$  adds damping at the input, which lowers the probe bandwidth. The impedance of the external mode is not constant and depends on factors such as how the probe is being held and the position of the probe cable. Since the impedance between system ground and probe ground is relatively high,  $V_{IN}$  induces signals onto probe ground that propagate along the external mode of the coaxial cable. Discontinuities in the external mode cause reflections that return back to the probe input and distort the measurement. This can cause measurements to be unrepeatable and inaccurate.

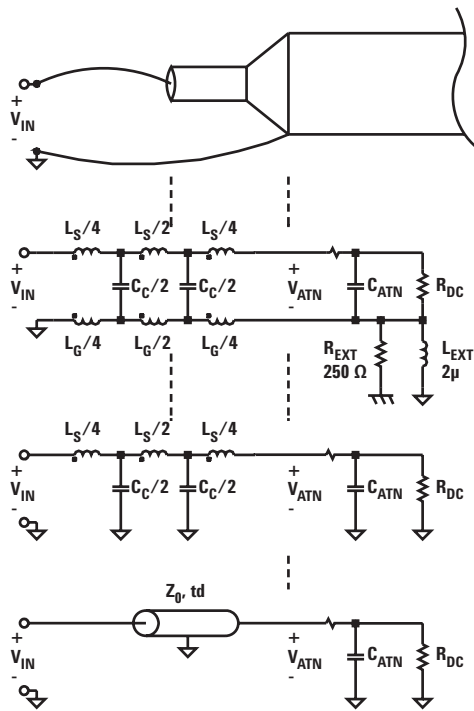

**Figure 2. Physical sketch and electrical model of the parasitics between a point being probed and the probe attenuator**

Poorly grounded probes are more predictable than ungrounded probes. "Poorly grounded" just means that the impedance of the connection to probe ground is high enough that a significant voltage still exists between the probe ground and system ground. Using a ground wire that is a few inches long is an example of a poorly grounded probe. Poorly grounded probes have the same problems as ungrounded probes but to a lesser degree since the impedance of the connection to

## Electrical Model (continued)

probe ground is lower.

To achieve the most repeatable and accurate measurements, the probe ground should be as close as possible to the system ground. This keeps the voltage between the two near zero, even when being driven by very fast signals at the input, and hence avoids launching signals down the external mode of the coaxial cable. The best practice is to use a coaxial ground socket or a minimum length connection to probe ground. If a probe is well grounded, then the model can be simplified by grounding all nodes between system ground and probe ground as shown in the bottom of figure-2. The resulting circuit is a single transmission line that has the input impedance of the attenuator,  $R_{DC}$  in parallel with  $C_{ATN}$ , at the far end.  $R_{DC}$  has no effect on the high-frequency behavior of the circuit since its impedance is many orders of magnitude higher than the total capacitance of the line. This leaves  $C_{ATN}$  at the end of a short transmission line. With today's probes  $C_{ATN}$  is small, around 0.2-pF, compared to the total capacitance of the transmission line, which is around 0.7-pF.

In order to focus on the fundamental problem,  $C_{ATN}$  will be removed from the model. This introduces some inaccuracy in the model that will be revisited later. What remains is a short transmission line that models the connection between the point being probed and the internal attenuator of the probe. The first part of the connection is variable and depends on the connection accessories that are being used with the probe. The second part of the connection is fixed and is internal to the probe.

Looking at the left side of figure-3, the input impedance of a transmission line that is open at the far end looks like a capacitance whose value is  $td/Z_0$  at frequencies well below  $1/(4*td)$ . At the 1/4 wave frequency, the input impedance resonates down to zero. Between the 1/4 wave and 1/2 wave frequencies the input impedance looks like inductance, and at the 1/2 wave frequency it resonates high to infinity. With probes the big problem is the first resonance at  $1/(4*td)$ . The input impedance of probes is often described as capacitance at high frequencies, but as frequency approaches  $1/(4*td)$ , the input impedance is lower than a simple capacitance would be.

The transmitted response,  $V_{OUT}/V_{IN}$ , of a transmission line that is open at the far end is one (flat) at frequencies well below  $1/(4*td)$ . At the 1/4 wave frequency, the transmitted response resonates high, and between the 1/4 wave and 1/2-wave frequencies it returns to one. Again, the big problem with probes is the first resonance at  $1/(4*td)$ , where the response becomes excessively peaked.

If the transmission line is 60-ps long, the first resonance occurs just above 4-GHz. The capacitance at the output (right) side of the line that was previously excluded from the model will lower the frequency of the first resonance to below 3.5-GHz. If the goal is to build a probe that has high input impedance and flat response up to 4-GHz, this is a poor starting point.

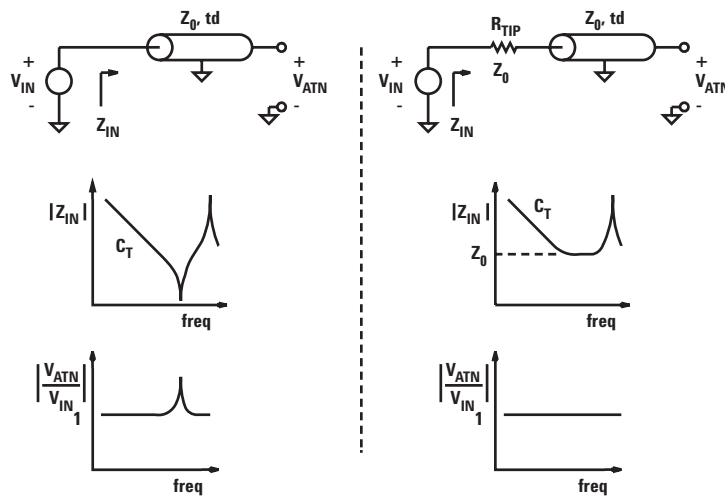

Figure 3. Input impedance and response of open-ended transmission lines

## Electrical Model (continued)

One way to avoid the problem is to reduce the physical size of the connection, which reduces the electrical length of the transmission line and keeps the first resonant frequency well above the desired bandwidth of the probe. To build an accurate 4-GHz probe, nothing but an ultra-short stubby point at the probe's input will suffice. Including a short socket at the input requires too much electrical length to avoid resonating below 4-GHz. Although a probe with an ultra-short input has excellent high-frequency fidelity, the short input is difficult to connect to various points on a typical circuit. This illustrates the fundamental tradeoff between fidelity and ease of use.

Another way to fix the problem is to put a load termination at the output (right) side of the line. Unfortunately, this makes the dc input resistance of the probe equal to  $Z_0$ , which is around 130-ohms and far lower than most circuits can tolerate.

A better way to fix the problem is to put a source termination at the input (left) side of the line. The difficulty with this solution is that physically, this is where the probe makes contact to the point on the circuit being measured, **it's not inside the probe!** A probe tip can be made that incorporates resistance right behind the point being probed. Although mechanically challenging, this solution is electrically ideal. A schematic of this solution is shown on the right side in figure-3. The input impedance never resonates low, in fact it never goes below  $R_{TIP}$ , and the transmitted response is one (flat) for all frequencies. The capacitance at the output side of the line that was excluded from the model will make the transmitted response less ideal but still quite acceptable well beyond the first resonant frequency. This solution allows a physically longer, easier-to-use connection to achieve excellent high-frequency fidelity.

Notice that the resistor that forms the source termination (the "damping" resistor) needs to be on the input (left) side of the line. Placing a damping resistance on the output (right) side of the line does little to reduce the resonance at the input of high-bandwidth probes.

As a side note, if the input capacitance of a probe is dominated by the input capacitance of the attenuator, as is the case with many lower bandwidth probes, then addition of a damping resistor at the output (right) side of the line can be beneficial. With high-bandwidth probes, however, the input capacitance is dominated by the connection to the point being probed rather than the attenuator, hence the damping resistor is only beneficial when placed at the input (left) side of the connection to the point being probed.

## Probe Characteristics

Before measuring the characteristics of a probe, the characteristics should be clearly defined. This paper focuses on the linear characteristics of probes such as input impedance, response, and output impedance. Although quite important, noise floor and non-linear issues such as dynamic range, slew rate, and offset range are not discussed here.

An ideal probe has infinite input impedance and flat response, which implies the following two things. Connecting a probe with infinite input impedance to a circuit has no effect on the circuit. The signal at the output of a probe with flat response is identical to the signal at the input of the probe. When a real probe is connected to a circuit and a measurement is made, two non-ideal things happen. First, the input impedance of the probe is added to the circuit, which changes the signal being measured. Second, the response of the probe causes the signal at the probe output to be different than the signal at the probe input. It is useful to keep the effect of input impedance separate from

the effect of response because only the input impedance of the probe, and not the response of the probe, affects the signal that actually exists in the circuit being measured.

High-speed digital circuits often require the use of high-bandwidth probes. Designers of these circuits typically think in terms of time-domain parameters and are not as familiar with frequency-domain parameters. Mathematically, if either the time-domain impulse response or the frequency-domain transfer function (transmitted response) is known, then the other can be calculated. Also, if the step response is known, then the impulse response is known since impulse response is just the derivative of step response. This means that if the frequency-domain transmitted response is known, then the time-domain step response is also known, and vice versa. These are the characteristics that are most commonly specified. All of the above is only true if the response, either time domain or frequency domain, is accurately measured, which is rarely the case.

## Probe Characteristics (continued)

In the time domain, the step response of a probe is the signal at the probe output, while the input is driven with a perfect step. The step sources in TDR scopes have 30-35 ps rise times and are flat to within a few percent, which seems good enough to measure today's high-bandwidth probes. This step source exists in a 50-ohm environment, and when doubly terminated, presents a 25-ohm source impedance to the probe. Unfortunately, the probe's input impedance can significantly load a 25-ohm source at high frequencies. So although the source step is good enough when no probe is connected, after connecting the probe the signal at the probe input may no longer be a near perfect step. If the probe response is perfect, then the step at the probe output will be identical to the step at the probe input.

A qualitative assessment of step response can be made by comparing the measured step at the output of a probe to the measured step at the input of a probe while the probe is connected to a source. However, in order to ascertain the true step response of a probe, the waveform that is measured at the input needs to be de-convolved from the waveform that is measured at the output. To avoid doing the de-convolution, the rise time of the probe's step response can be roughly estimated by using the following "sum of squares" rule of thumb on the measured waveforms at the probe input and output:

The rise time of the step source without the probe connected cannot be used in the sum of squares estimation since this is not the rise time at the probe input while the probe is connected. Also, if the waveform at the probe input is not a fairly flat step while the probe is connected, then there can be significant error in this calculation. The need to use de-convolution makes it cumbersome to accurately measure the true step response of a probe.

In the frequency domain, the transmitted response of a probe is the signal at the probe output, while the input is driven with a constant magnitude (flat), zero-phase sine wave across frequency. Again, even when starting with a flat 25-ohm source, after connecting the probe the signal at the probe's input will no longer be flat across all frequencies due to the input impedance of the probe. In order to measure the transmitted response of a probe, both the probe input and output need to be measured while the probe is connected. The response can then be calculated as the measured  $V_{OUT}/V_{IN}$ , remembering that these are complex quantities.

$$TRise\_probe = \sqrt{TRise\_output\_measured^2 - TRise\_input\_measured^2}$$



# Measurement Setup

The procedure used to make a measurement is really what defines what is being measured. Looking at a graph of a probe's "response" has little value if the setup and procedure used to make the measurement are not described. Regardless of whether the time-domain or frequency-domain response is being measured, the signal at both the probe input and probe output needs to be measured.

Figure-4 shows a setup that allows this. A fixture consisting of an exposed 50-ohm transmission line can be used to allow the probe to be connected to the source and also to allow the signal at the probe input to be measured. To enable an accurate measurement of  $V_{IN}$ , this fixture needs to have minimal loss and reflection between the point that is probed and the connection on the right side. Both the right side of the fixture and the probe output need to be connected to terminated 50-ohm systems such as the inputs of a microwave oscilloscope, power meters, or calibrated ports of a vector network analyzer (VNA).

When using a VNA,  $V_{IN}$  is ascertained from an S21 measurement and  $V_{OUT}$  is ascertained from an S31 measurement response is calculated as:

$$\text{Response} = V_{OUT} / V_{IN} = S31 / S21$$

This setup can also be used to measure the input impedance of the probe. If the reference plane calibration is performed with the fixture in the through path and the reference plane is at, for example, the right side of the fixture, then the input impedance of the probe can be calculated

from the S21 measurement of  $V_{IN}$  as follows:

$$Z_{IN} = (Z_0/2) * Prb_{IN} S21 / (1 - Prb_{IN} S21) = 25 * Prb_{IN} S21 / (1 - Prb_{IN} S21)$$

It is more common to ascertain input impedance from an S11 measurement. Unfortunately, when using an S11 measurement the phase of the measurement changes with the exact location of the probe. Most VNAs have an adjustment for this, but the mere fact that it is adjustable means the answer is somewhat arbitrary. In contrast, the phase of the S21 measurement does not change as the probe location changes. The time delay of the through path during the measurement is exactly the same as the time delay of the through path during the calibration, hence the measurement is inherently calibrated.

For best accuracy, the calibration factors in the VNA can be shifted by the time delay between the center of the fixture and the right side of the fixture. This corrects for the error caused when the probe is not connected exactly at the reference plane but rather to the left of the reference plane. This error is fairly small, even without the correction.

The output impedance of a probe is not a significant issue in most cases. However, when a probe is used in front of an instrument that has a poor 50-ohm termination, reflections from the instrument propagate back up the probe cable and reflect again from the non-ideal output impedance of the probe amplifier. This causes perturbations in the step response of the probe at twice the time delay of the cable after the step edge. Here, an S33 measurement is all that is necessary to assess the quality of the probe's output impedance since the phase of the output impedance is not important.

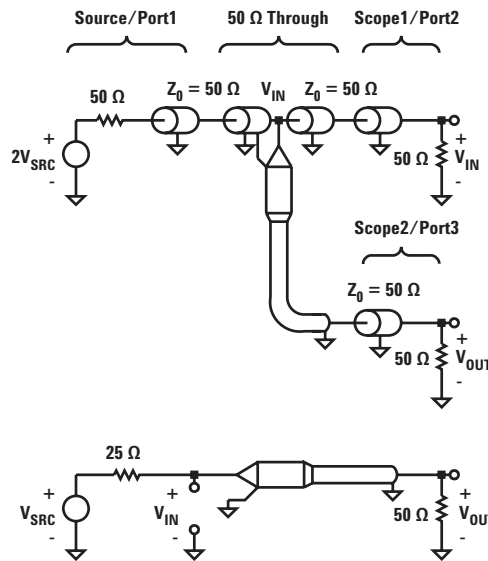

Figure 4. Setup to accurately measure probe input impedance and response



## Practical Considerations

Why would users ever need to measure the input impedance or response of their probes when these things have already been measured by each probe manufacturer?

First of all, it's always good to do sanity checks when making measurements. For example, touching the tips of an ohm meter together and measuring "0" before making a resistance measurement instills confidence in subsequent measurements. Even if a probe isn't going to be fully characterized, knowing how to do a reasonable sanity check has value.

Also, since the input impedance and response of a probe are very dependent on the probe's connection accessories, it's a good idea to measure these quantities for each unique connection accessory. Manufacturers usually do not show the probe's response when used with various connection accessories, especially big old grabbers! When using a probe with less than ideal connection accessories, you might want to have some idea of what the overall probe response looks like.

It's easy to do a quick sanity check in the time domain by probing a point that is being driven from a step or pulse generator with reasonably fast rise times and then comparing the signal at the probe output to the signal at the probe input. As shown in figure-4, this can be done by using an exposed 50-ohm transmission line and two scope inputs. A perfect step is not required to do a good sanity check. Any imperfections that exist at the probe input should be accurately reproduced at the probe output.

Many scopes have a probe calibration signal with reasonably fast rise times that can drive a 50-ohm scope input. This calibration signal and an exposed 50-ohm through path are all that are needed to do good sanity checks on probes and their connection accessories. If the input impedance of the scope is not a good 50-ohms at high frequencies, a high-quality 50-ohm attenuator can be placed between the 50-ohm through path and the scope input. This will reduce the error between the signal at the scope input and the signal at the probe input, error that is caused by reflections from the imperfect input impedance of the scope.

## Undamped vs. Damped Connection Accessories

Figures-5a, 5b, and 5c compare measurements that were made with well grounded, 2.5-GHz probes using 2-inch signal lead wires. The probe on the left uses a 2-inch wire that is connected directly to the point being probed. The probe on the right uses the same length of wire but has an optimum, 215-ohm resistor between the point being probed and the lead wire. This makes the structure at the probe input on the right look like a source-terminated transmission line. Excluding the connection accessories, the two probes are similar but not identical because the probe on the right is optimized to be used with properly damped connection accessories and the probe on the left is optimized to be used with an undamped metal pin.

The frequency-domain graphs in figure 5a show that the two probe connections have similar input impedance at lower frequencies. However, the undamped connection resonates low to  $\sim 15$ -ohms at  $\sim 750$ -MHz, while the damped connection never resonates low and doesn't go below 230-ohms up to 4-GHz.

The frequency-domain graphs of  $V_{IN}$ ,  $V_{OUT}$ , and Response ( $V_{OUT}/V_{IN}$ ) reveal a few different issues. Looking at the measured  $V_{IN}$ , the undamped connection loads the 25-ohm source severely at  $\sim 750$ -MHz, reducing  $V_{SRC}$  by  $\sim 9$ -dB. Remembering that 6-dB is a factor of 2 in voltage, if the input impedance of the probe were the same as the source impedance,  $V_{SRC}$  would be reduced by 6-dB. It makes intuitive sense that the measured input impedance of 15-ohms loads the 25-ohm source by more than 6-dB at 750-MHz. The measured  $V_{IN}$  on the right loads the source by less than 1 dB which indicates that the damped connection has far less effect on the 25-ohm source than the undamped connection has at higher frequencies.

If the response of a probe is perfect, the output exactly tracks the input across all frequencies. The output of the probe on the left of figure-5a indicates that the measured signal at 750-MHz is 14-dB, or a factor of 5, above the low frequency level. In reality, the measured signal is 9-dB, or a factor of 2.8, above the low frequency level. This means that the output is 23-dB above the input, or in error by 23-dB at 750-MHz. The response graph of  $V_{OUT}/V_{IN}$  shows this error of 23-dB at 750 MHz. In contrast, the response of the properly damped probe on the right is not peaked at any frequency. Even while using a 2-inch lead wire, the properly damped probe has less than 3-dB of error up to 1.5-GHz!

# Undamped vs. Damped Connection Accessories (continued)

Undamped Probe

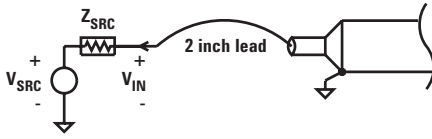

Damped Probe

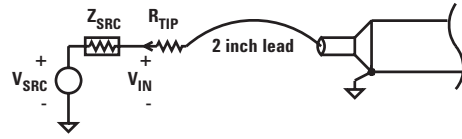

Input Impedance

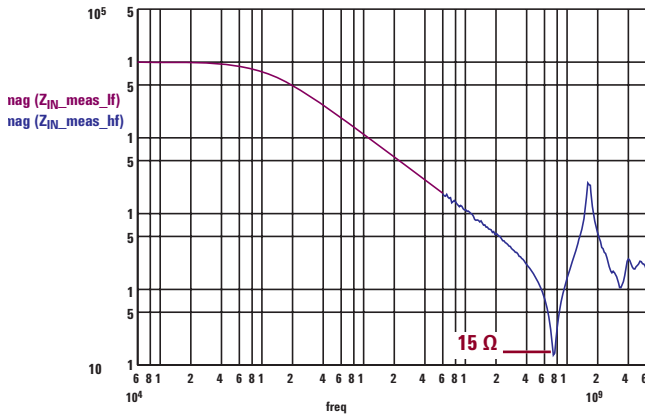

Input Impedance

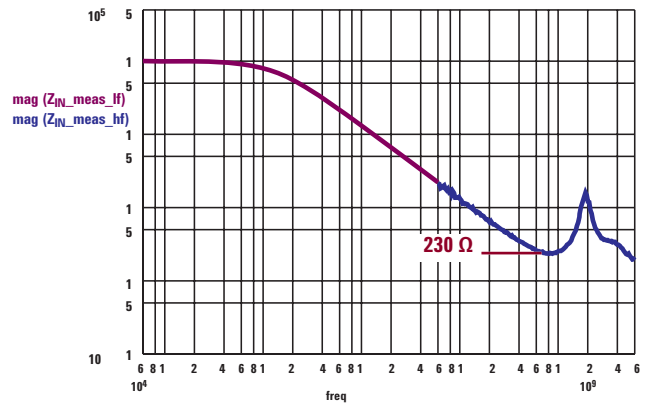

Top:  $V_{IN}$  and  $V_{OUT}$  Bottom:  $V_{OUT}/V_{IN}$

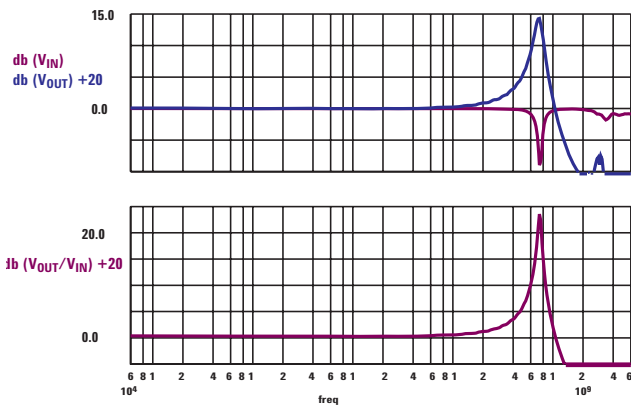

Top:  $V_{IN}$  and  $V_{OUT}$  Bottom:  $V_{OUT}/V_{IN}$

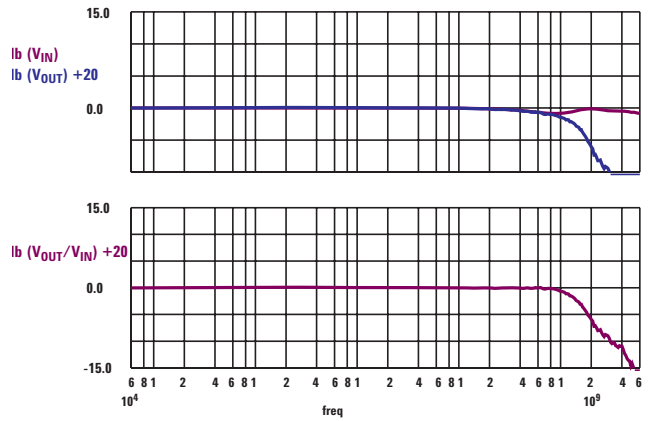

Figure 5a. Frequency-domain comparison of a probe using undamped, 2 inch wire accessory (left) and a probe using properly damped, 2-inch wire accessory (right)

# Undamped vs. Damped Connection Accessories (continued)

Various time-domain measurements also were made with these two probes in a 25-ohm system. As shown in figure-5b, when measuring low-frequency, 66-MHz square waves with relatively slow, 2-ns rise times, the output of both probes accurately represents the signals at their inputs. When measuring square waves with 1-ns rise

times, the output of the properly damped probe is accurate, but the output of the undamped probe indicates that the input has faster rise times than it really does. Notice that in this case, the peaked response of the undamped probe shows that the signal being measured looks better than it really is. This seems impossible to many users.

$V_{IN}$  and  $V_{OUT}$ , 2 ns Rise Times, 66 MHz Clock

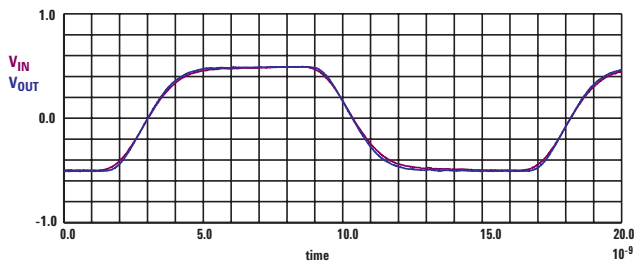

$V_{IN}$  and  $V_{OUT}$ , 2 ns Rise Times, 66 MHz Clock

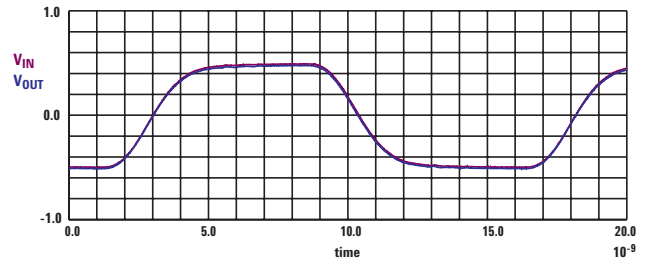

$V_{IN}$  and  $V_{OUT}$ , 1 ns Rise Times, 250 MHz Clock

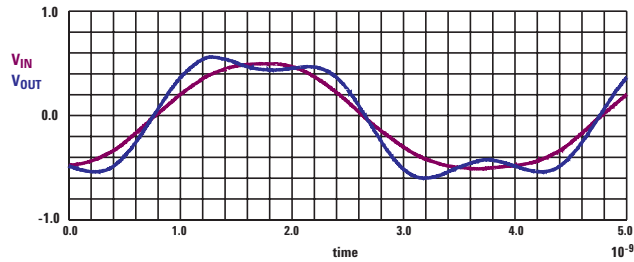

$V_{IN}$  and  $V_{OUT}$ , 1 ns Rise Times, 250 MHz Clock

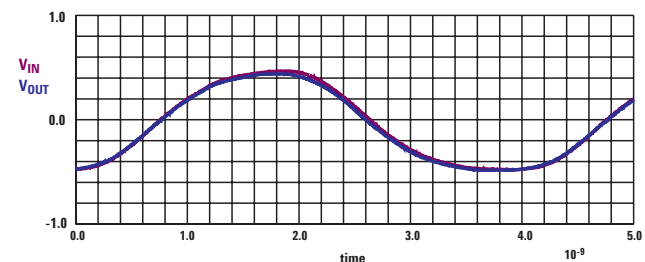

Figure 5b. Time-domain comparison of a probe using undamped, 2 inch wire accessory (left) and a probe using properly damped, 2-inch wire accessory (right). Measurements performed on square waves with slower rise times

## Undamped vs. Damped Connection Accessories (continued)

As shown in figure 5c, when measuring square waves with faster, 250-ps rise times, the output of the undamped probe has excessive overshoot and ringing. This overshoot and ringing is easy to identify when measuring low-frequency, 66-MHz square waves. However, when measuring higher-frequency square waves, as shown in the lower graphs, the measurement error caused by the probe becomes larger and less obvious. When a probe is being used to make real measurements in a real system, the user doesn't have the luxury of viewing the signals at both the probe input and output. The user only gets to see the signal at the probe output. In order to accurately infer what a signal at the input really looks like based on the signal at the output, the user needs to know what the response of the probe is, which is more than just knowing the specified probe bandwidth.

What most users really want is simply to know that the performance of their measurement system is good enough that it is not causing significant measurement error.

At a bare minimum, a user needs to be aware of where the threshold is between what is good enough and not good enough, and how to detect when this threshold has been crossed while making measurements.

First, consider a probe with a response that is excessively peaked in the frequency domain, such as the probe on the left in figure-5a. When measuring low-frequency square waves, this means that the signal at the probe output might have a lot more overshoot and ringing than the signal being measured. When measuring higher-frequency square waves such as system clocks, the signal at the probe output might provide a very distorted view of the signal at the probe's input. The magnitude of the discrepancies depends on many variables including the magnitude and frequency of the peaking in the probe, the frequency of the input signal, and the rise time of the input signal. Put simply, it's rather complicated to figure out how accurate or inaccurate a particular measurement is when the probe response is excessively peaked.

Next, consider a probe that has a flat, low pass response, such as the probe on the right in figure-5a. When measuring low-frequency square waves, the rise time at the probe's output will be limited to the rise time of the probe itself. When measuring higher-frequency square waves such as system clocks, the effect is exactly the same. Put simply, it's easy to tell how accurate or inaccurate a measurement is when the probe response is not excessively peaked or, said differently, is properly damped. More specifically, when measured rise times are significantly slower than the probe rise time, the signal at the probe input is accurately represented by the signal at the probe output. When measured rise times approach the probe rise time, the signal at the probe input has faster rise times than the signal at the probe output. This is the only discrepancy between the real signal and the measured signal. Excessive overshoot and ringing are never caused by a properly damped probe, regardless of the frequency or rise time of the signal being measured.

# Undamped vs. Damped Connection Accessories (continued)

$V_{IN}$  and  $V_{OUT}$  250 ps Rise Times, 66 MHz Clock

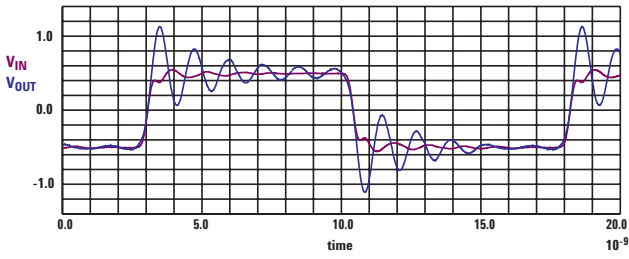

$V_{IN}$  and  $V_{OUT}$  250 ps Rise Times, 66 MHz Clock

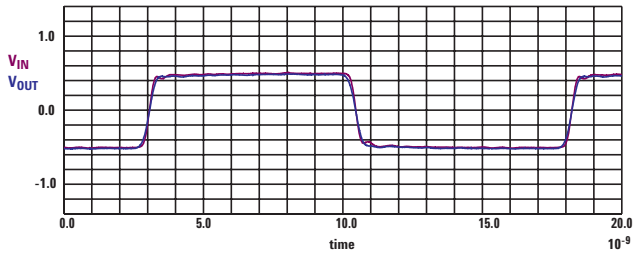

$V_{IN}$  and  $V_{OUT}$  250 ps Rise Times, 250 MHz Clock

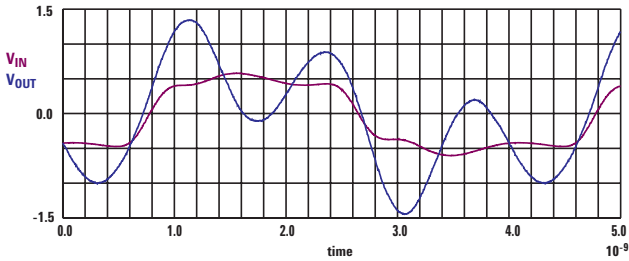

$V_{IN}$  and  $V_{OUT}$  250 ps Rise Times, 250 MHz Clock

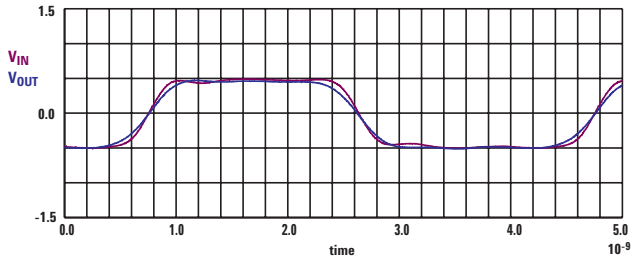

$V_{IN}$  and  $V_{OUT}$  250 ps Rise Times, 500 MHz Clock

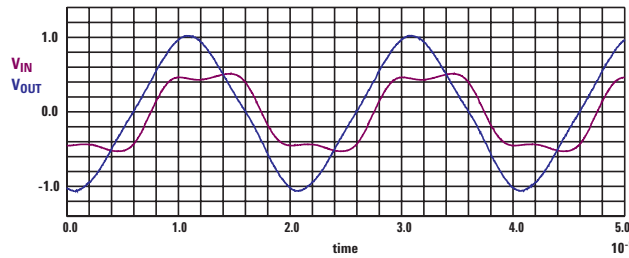

$V_{IN}$  and  $V_{OUT}$  250 ps Rise Times, 500 MHz Clock

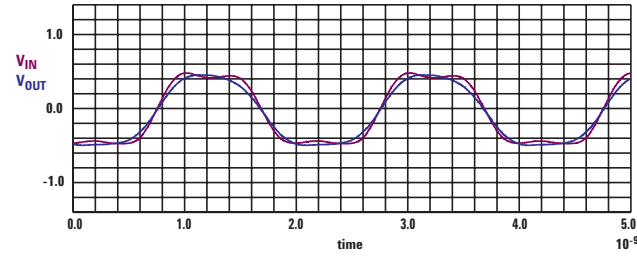

$V_{IN}$  and  $V_{OUT}$  250 ps Rise Times, 750 MHz Clock

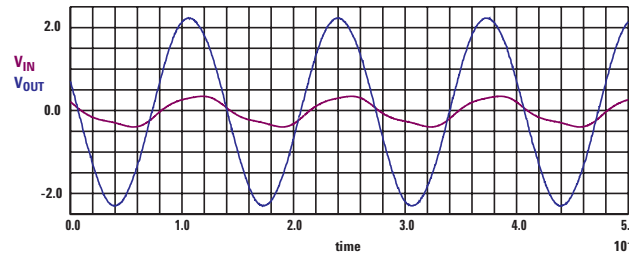

$V_{IN}$  and  $V_{OUT}$  250 ps Rise Times, 750 MHz Clock

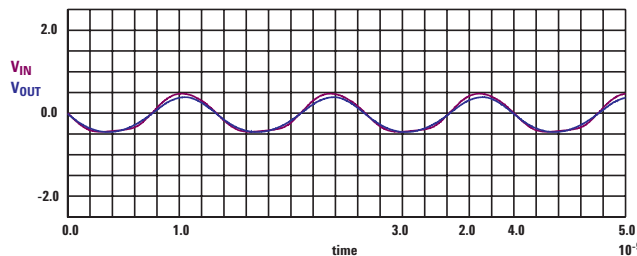

Figure 5c. Time-domain comparison of a probe using undamped, 2 inch wire accessory (left) and a probe using properly damped, 2 inch wire accessory (right). Measurements performed on square waves with faster rise times

## Comparison of Best Connection Accessories

Figure 6 shows measurements made with two different 4-GHz probes. Both are using the connection accessories that the probes are specified with. The probe on the right incorporates an optimum resistance at the point being probed and the probe on the left does not. The probe on the left is not using any external connection accessories, the source is connected directly to the probe's input socket. The electrical length of this internal socket along with the capacitance of the internal attenuator at the end of the socket cause the input structure to resonate within the specified bandwidth of the probe. Although the "-3-dB bandwidth" of this probe is 4.5-GHz, there is +3-dB of error at 2.8-GHz. For reference, 1-dB is ~12% in voltage. The probe on the right is non-resonant throughout its entire bandwidth. The lowest frequency at which there is 3-dB of error is at the probe bandwidth, which is 4.8-GHz.

Figures-7a and 7b show measurements that were made on the same probes shown in figure-6. In figures-7a and 7b, the probes are being used with the best, commonly used connection accessories (as opposed to the connection accessories that the probes are specified with). These are the shortest accessories that are typically used when browsing around a circuit board, making measurements in various places on the board. For the probe on the left, this adds a pogo pin to the ground connection and a ~0.15-inch metal pin to the signal connection. For the probe on the right, this changes the coaxial ground connection to a wide, ground blade connection and changes the value of resistance in the signal connection at the point being probed. The "-3-dB bandwidth" of the probe on the left is 3.1-GHz, but more significantly there is +3-dB of error at 1.8-GHz. For the probe on the right, the lowest frequency at which there is 3-dB of error is at the probe bandwidth, which is 3.5-GHz.



# Comparison of Best Connection Accessories (continued)

Undamped, Specified-Performance Connection Accessory

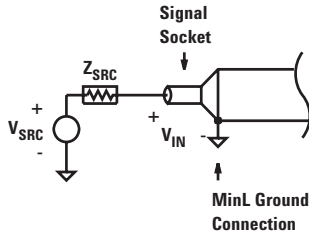

Damped, Specified-Performance Connection Accessory

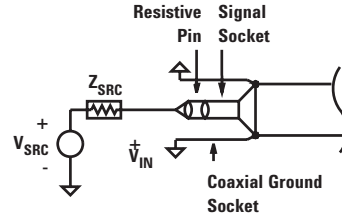

Input Impedance

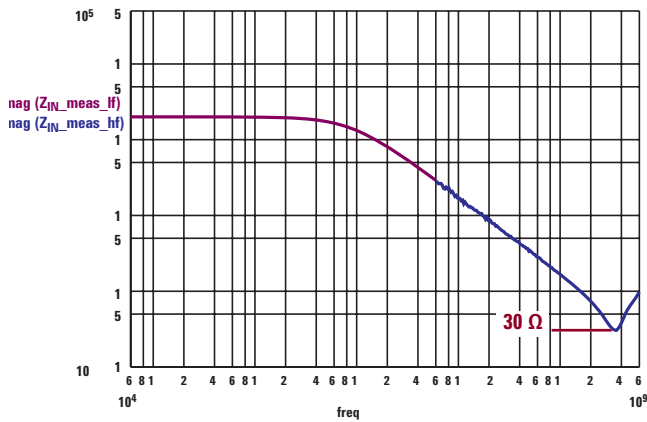

Input Impedance

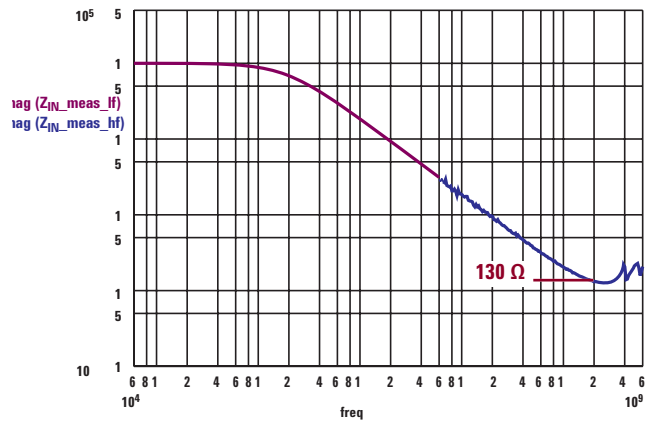

Top:  $V_{IN}$  and  $V_{OUT}$  Bottom:  $V_{OUT}/V_{IN}$

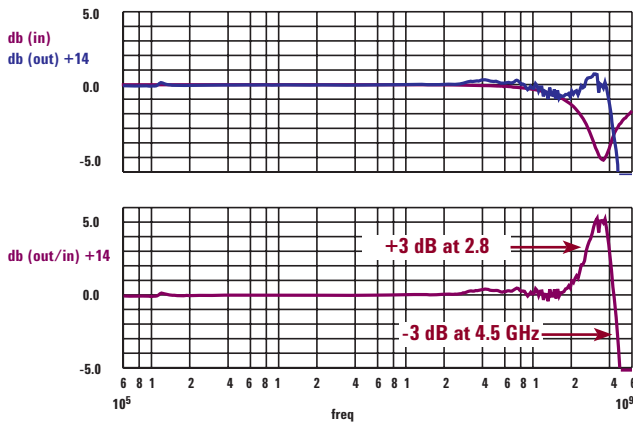

Top:  $V_{IN}$  and  $V_{OUT}$  Bottom:  $V_{OUT}/V_{IN}$

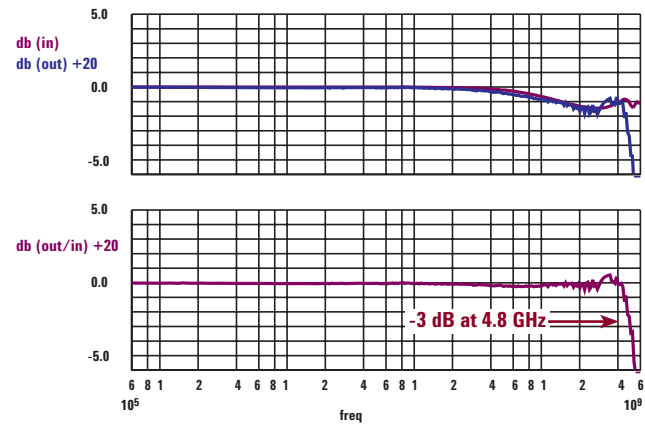
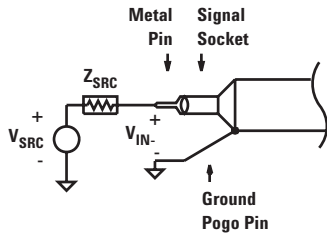

Figure 6. Comparison of a probe using undamped, "specified-performance" connection accessory (left) and a probe using properly damped, "specified-performance" connection accessory (right)

# Comparison of Best Connection Accessories (continued)

Undamped, Best-Usable Connection Accessory



Damped, Best-Usable Connection Accessory

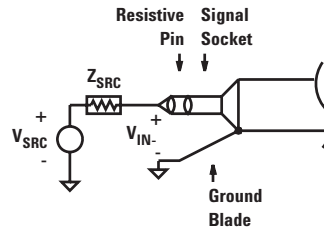

Input Impedance

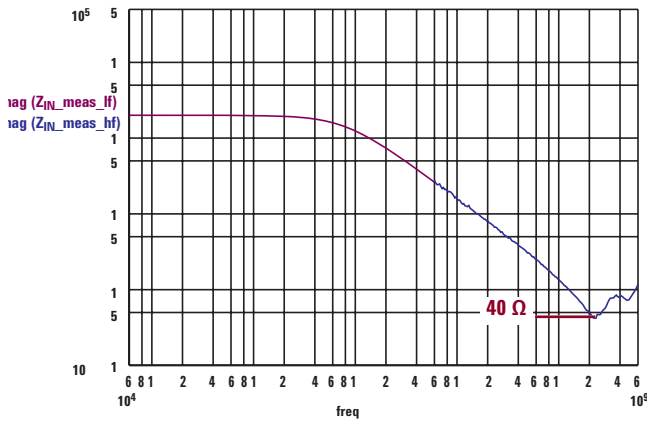

Input Impedance

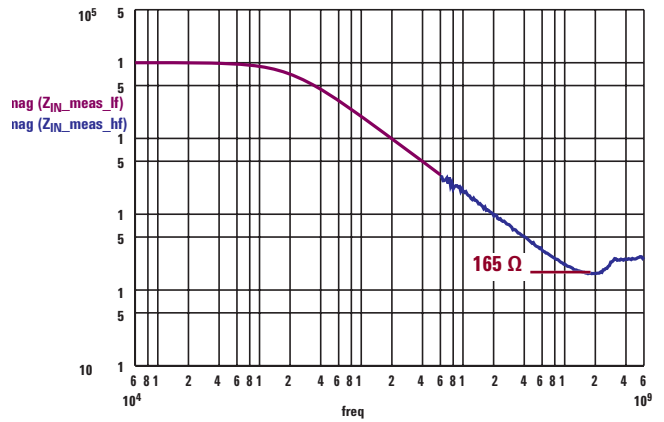

Top:  $V_{IN}$  and  $V_{OUT}$  Bottom:  $V_{OUT}/V_{IN}$

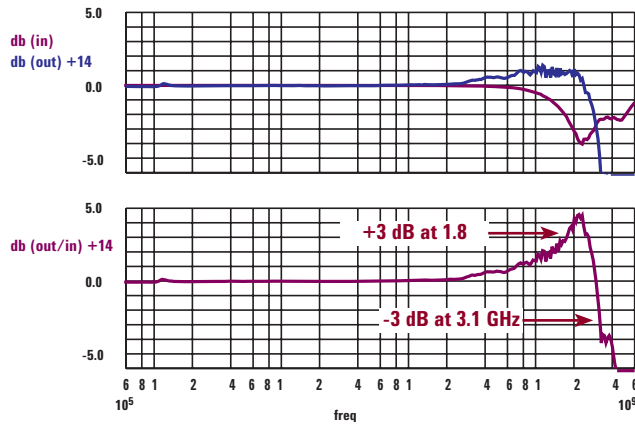

Top:  $V_{IN}$  and  $V_{OUT}$  Bottom:  $V_{OUT}/V_{IN}$

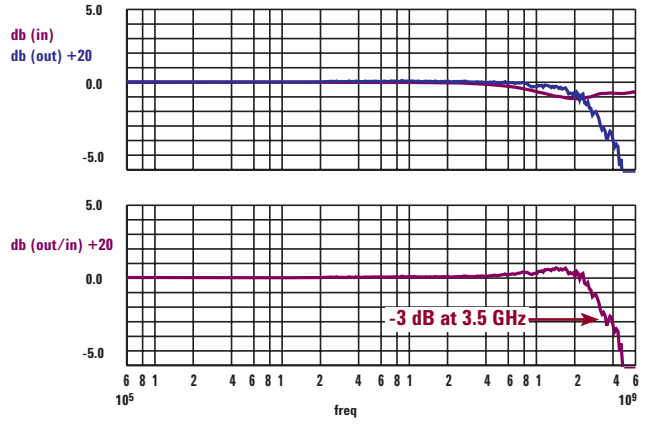

Figure 7a. Comparison of a probe using undamped, "best-usable performance" connection accessory (left) and a probe using properly damped, "best-usable performance" connection accessory (right)

## Comparison of Best Connection Accessories (continued)

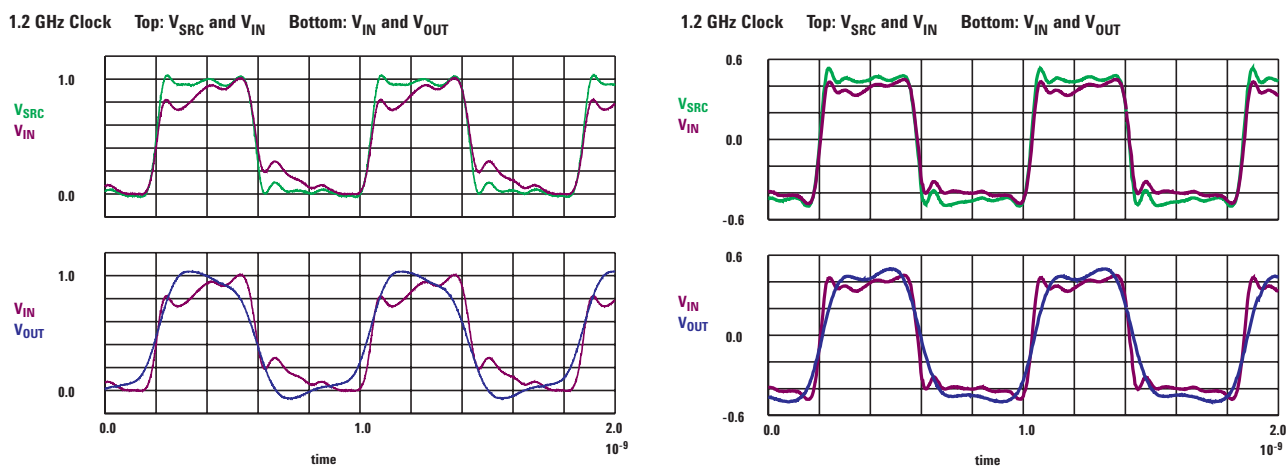

Figure 7b. Comparison of a probe using undamped, “best usable performance” connection accessory (left) and a probe using properly damped, “best usable performance” connection accessory (right)

For those who are more familiar with time-domain parameters, measurements of a 1.2-GHz clock are shown in figure-7b. The top part of figure-7b shows the 25-ohm source without the probe connected,  $V_{SRC}$ , and with the probe connected,  $V_{IN}$ . The probe with the higher input impedance affects the signal the least. The bottom part of the graph shows the signal at the probe input,  $V_{IN}$ , along with the signal at the probe output,  $V_{OUT}$ . The probe with the least error in the response most accurately represents the signal at the probe’s input.

All of the measurements in this application note were made in a system that has a nearly ideal 25-ohm source impedance. What happens to these measurement results when probes are used to measure real signals in real systems that have very

different, usually complex source impedances? Simply put, the response of a probe,  $V_{OUT}/V_{IN}$ , is not a function of anything other than the probe itself, including connection accessories as being part of the probe. If the response of a probe is peaked, the probe output will always indicate that the signal being measured is more peaked than it actually is. If the response of a probe is flat, the probe output will always be an accurate representation of the signal being measured as long as the frequency content of the signal being measured is within the bandwidth of the probe.

When probes are used in systems with different source impedances, what **does** change is the effect that the input impedance of the probe has on the circuit being measured. For systems with real (not complex) source impedances,

the effect of the probe’s input impedance is fairly simple to predict. For most systems, however, the source impedance at the point being probed is not real and is difficult to ascertain. Generally speaking, connecting a resonant impedance to a circuit probably has a worse effect than connecting a non-resonant impedance. Probe users that really need to know how much a probe is affecting their circuit need to simulate their circuit with an accurate model of the input impedance of the probe. As shown in the measurements in this application note, at high frequencies the model is completely dependent on the connection accessories used with the probe. There is no such thing as a single model that is accurate for a given probe with various connection accessories.

## Summary

Comparing the measurements in figures-6 and 7 shows that probe fidelity is significantly affected by a relatively minor change in the probe connection accessories. Considering measurements in figures-5a, 5b, and 5c, connection accessories can completely dominate signal fidelity. To understand the reason for these variations, an accurate model of the connection accessories, including the part of the connection that is internal to the probe, must be made. Analysis of this model clearly reveals the benefits of source-terminating the transmission line formed by the connection to the point being probed. A probe that incorporates an optimum resistance at the point being probed has greatly improved fidelity for any given connection accessory.

The measurements shown in this application note are just a subset of the connection schemes that are often used with probes. In practice, connection lengths can be anything between near zero and quite a few inches. Also, it is often necessary to use a less than optimum connection to ground. In this case, an accurate model requires coupled transmission lines at the input, as shown in figure-2. Using less than optimum connections doesn't mean a measurement is invalid, it just means the user should be aware that the fidelity of the measurement may be significantly less than what the specified bandwidth of the probe implies.

## Conclusion

Laws of physics dictate that longer connections to the point being probed produce compromised high-frequency fidelity. This creates a fundamental tradeoff between fidelity and ease of use with high-bandwidth probes. Incorporating an optimum resistance at the point being probed greatly improves the fidelity of any given connection, which allows the use of longer, easier-to-use connections. Probes are the first component of a measurement system, and the fidelity of the overall measurement system is often limited by the fidelity of the probing system. A probe designed with optimally damped connection accessories produces a non-resonant input impedance and flat response, which can keep the measurement error due to the probe low enough to be negligible in many measurement systems.

## Related Literature

Publication Title	Publication Type	Publication Number
<i>Agilent 1156/57/58A Active Probes for Infiniium Oscilloscopes</i>	Product Overview	5988-3361ENUS
<i>Agilent Oscilloscope Probes and Accessories</i>	Selection Guide	5989-6162EN
<i>1156A 1.5 GHz Active Probe</i>	User's Guide	01156-97000
<i>1157A 2.5 GHz Active Probe</i>	User's Guide	01157-97000
<i>1158A 4 GHz Active Probe</i>	User's Guide	01158-97001

## Visit Our Websites

Agilent 1158A Active Probe  
[www.agilent.com/find/1158A](http://www.agilent.com/find/1158A)



### Agilent Email Updates

[www.agilent.com/find/emailupdates](http://www.agilent.com/find/emailupdates)

Get the latest information on the products and applications you select.



### Agilent Direct

[www.agilent.com/find/agilentdirect](http://www.agilent.com/find/agilentdirect)

Quickly choose and use your test equipment solutions with confidence.



[www.agilent.com/find/open](http://www.agilent.com/find/open)

Agilent Open simplifies the process of connecting and programming test systems to help engineers design, validate and manufacture electronic products. Agilent offers open connectivity for a broad range of system-ready instruments, open industry software, PC-standard I/O and global support, which are combined to more easily integrate test system development.



[www.lxistandard.org](http://www.lxistandard.org)

LXI is the LAN-based successor to GPIB, providing faster, more efficient connectivity. Agilent is a founding member of the LXI consortium.

Windows® is a U.S. registered trademark of Microsoft Corporation.

## Remove all doubt

Our repair and calibration services will get your equipment back to you, performing like new, when promised. You will get full value out of your Agilent equipment throughout its lifetime. Your equipment will be serviced by Agilent-trained technicians using the latest factory calibration procedures, automated repair diagnostics and genuine parts. You will always have the utmost confidence in your measurements.

Agilent offers a wide range of additional expert test and measurement services for your equipment, including initial start-up assistance onsite education and training, as well as design, system integration, and project management.

For more information on repair and calibration services, go to

[www.agilent.com/find/removealldoubt](http://www.agilent.com/find/removealldoubt)

## www.agilent.com

For more information on Agilent Technologies' products, applications or services, please contact your local Agilent office. The complete list is available at:

[www.agilent.com/find/contactus](http://www.agilent.com/find/contactus)

### Phone

#### Americas

Canada	(877) 894-4414
Latin America	305 269 7500
United States	(800) 829-4444

#### Asia Pacific

Australia	1 800 629 485
China	800 810 0189
Hong Kong	800 938 693
India	1 800 112 929
Japan	81 426 56 7832
Korea	080 769 0800
Malaysia	1 800 888 848
Singapore	1 800 375 8100
Taiwan	0800 047 866
Thailand	1 800 226 008

#### Europe

Austria	0820 87 44 11
Belgium	32 (0) 2 404 93 40
Denmark	45 70 13 15 15
Finland	358 (0) 10 855 2100
France	0825 010 700
Germany	01805 24 6333* *0.14€/minute
Ireland	1890 924 204
Italy	39 02 92 60 8484
Netherlands	31 (0) 20 547 2111
Spain	34 (91) 631 3300
Sweden	0200-88 22 55
Switzerland	(French) 44 (21) 8113811 (Opt 2)
Switzerland	(German) 0800 80 53 53 (Opt 1)
United Kingdom	44 (0) 7004 666666

Other European countries:  
[www.agilent.com/find/contactus](http://www.agilent.com/find/contactus)

Revised: March 23, 2007

Product specifications and descriptions in this document subject to change without notice.

© Agilent Technologies, Inc. 2001, 2008  
Printed in USA, June 20, 2008  
5988-6515EN



Agilent Technologies